





User Manual

Contents

I Precautions 01

I Product Overview 02-05

Front Side	02
Wiring Diagram	04
Accessories	05

I Home Screen 06-07

I Radio 08-09

I Bluetooth 10-14

I USB/SD 15-18

Music Playback	15
Video Playback	16
Picture	18

I Connections 19-27

Wired Android Auto Setup Steps	19
Wireless Android Auto Setup Steps	20
Wired CarPlay Setup Steps	22
Wireless CarPlay Setup Steps	23
Setup Steps of Wired MirrorLink for Android	24
Setup Steps of Wireless MirrorLink for Android	25
Setup Steps of Wired MirrorLink for iPhone	26
AirPlay	27

I Settings 28-30

I Specifications 31

I FAQ 32-33

Precautions

- Please seek professional help. Installation or servicing of this product by persons without training and experience in electronic equipment and automotive accessories may be dangerous and could expose you to the risk of electric shock, injury or other hazards.
- This product is only suitable for vehicles with 12V DC Power system. Do not install it on vehicles whose power supply is not 12V DC, or it may damage the product or cause a fire due to overvoltage.
- Do not allow this product to come into contact with liquids. Otherwise it may result in electrical shock or product damage.
- Please turn off the car and disconnect the positive battery terminal before installation to prevent product damage or fires caused by short circuits.
- All wires should be insulated after installation to prevent product damage or fires caused by short circuits.
- Please do not use the car audio after the engine is turned off for a long time, or it will drain the battery power.
- If this product is exposed to water damage or foreign matter is discovered in the product while you're driving, please park your vehicle in a safe place, turn off the ignition switch(ACC OFF) immediately and consult your dealer or Eonon customer service. Do not use this product in this condition because doing so may result in a fire, electric shock, or other failure.
- If smoke, strange noises or unusual odors occur during normal use, or any other abnormal signs appear on the LCD screen, please turn off the power immediately and consult your dealer or Eonon customer service. Do not use this product in this condition because doing so may result in a fire, electric shock, or other failure.
- Do not disassemble or modify this product. For interior inspection, adjustment or maintenance, please consult your dealer or Eonon customer service.
- Please use this product in accordance with traffic laws.
- Keep this manual handy as a reference for operating procedures and safety information.
- We reserve the right of final explanation.

Front Side





8

1. Built-in microphone
2. RST button
3. Tap to mute, tap and hold to turn off the unit
4. Home screen
5. Return
6. Volume+
7. Volume-
8. MicroSD card slot

Wiring Diagram

1. Backup Camera Input
2. Subwoofer Output
3. Video Input
4. Audio Input L
5. Audio Input R
6. Front Camera Input
7. Video Output 2
8. Video Output 1
9. Audio Output L
10. Audio Output R
11. Radio Antenna Input
12. Car Stereo Fuse

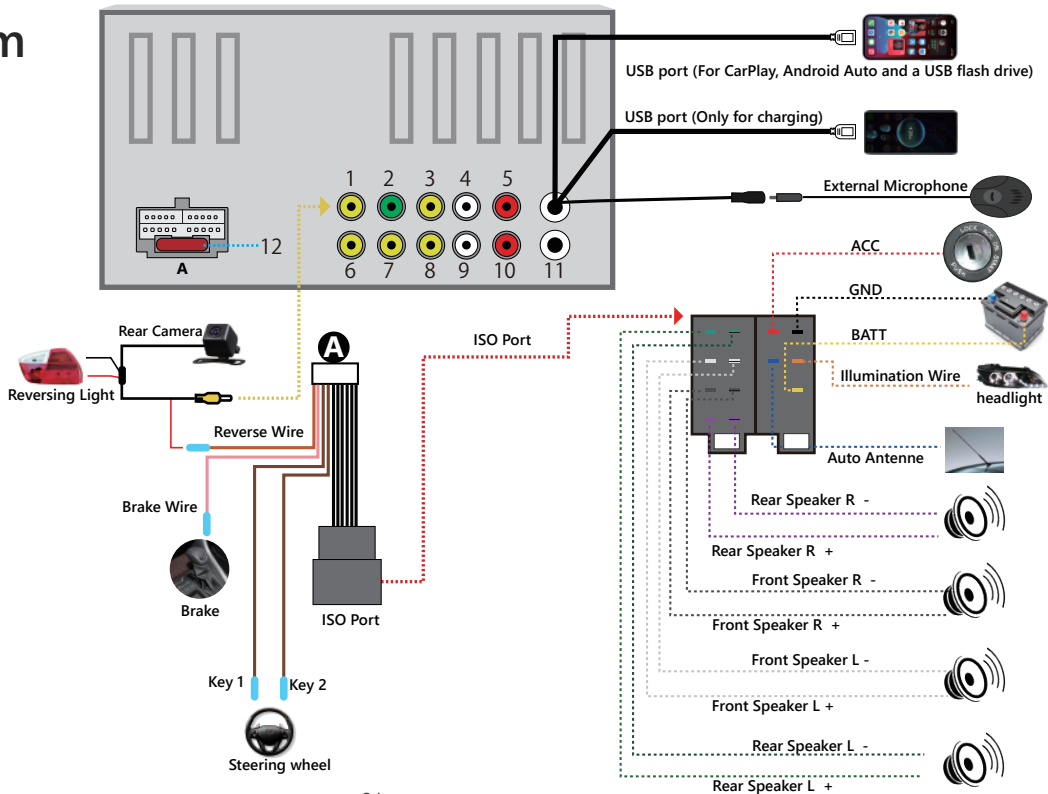

Accessories



Power Cable *1



External Microphone *1



10A Fuse *1



Screw *8

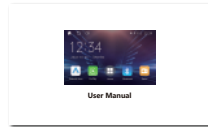

User Manual *1



A0125 Backup Camera *1

Home Screen



1. Tap to go to the home screen
2. Tap to go back to the previous page
3. Tap to adjust the volume
4. Display time and date
5. Display the connection status of Bluetooth and USB
6. Display the current time
7. Tap to turn on Android Auto
8. Tap to turn on CarPlay
9. Tap to go to the home screen
10. Tap to turn on Bluetooth
11. Tap to turn on the radio app
12. Tap to turn on MirrorLink
13. Tap to turn on AirPlay
14. Tap to enable the Bluetooth call function
Note: Please connect to Bluetooth first
15. Tap to view the files from the USB
16. Tap to view the files from the SD card
17. Tap to display the front camera image
Note: Backup camera image can only be displayed when in reverse.
18. Tap to view the audio transmitted through the AUX input
19. Tap to go to the setup menu

Radio

Please set the time zone for the radio after installing this product:

Setup--->  --->Radio Area

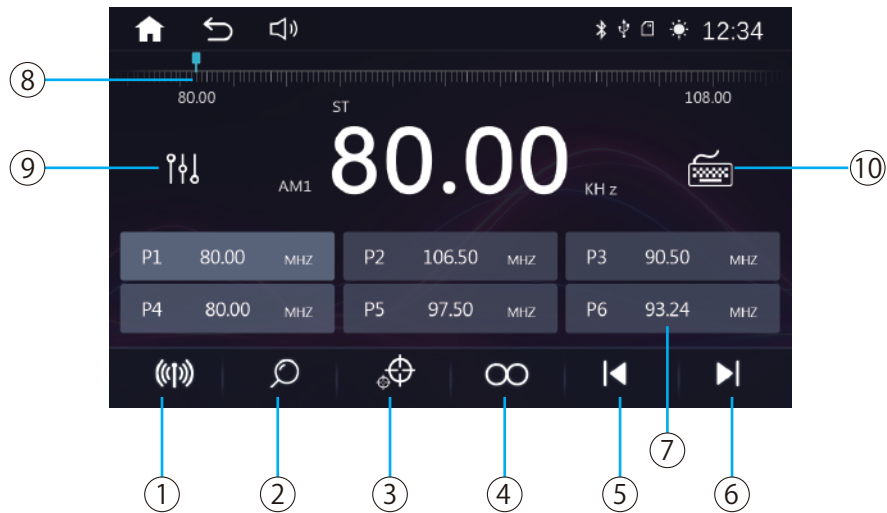

1. FM/AM switch.
2. Automatically search and save radio stations. Click to search for radio stations automatically from the lowest frequency to the highest frequency and it will save the searched stations in turn. Click again to stop searching.
3. LOC/DX switch. It's in LOC mode when the radio displays "LOC", meaning only radio signals within a short distance can be received.
4. Tap to switch between stereo/mono mode.
5. Switch to the previous radio station.
6. Switch to the next radio station.
7. Prestored radio stations.
A total of 30(18 FM, 12 AM) radio stations can be prestored. Press and hold the prestored radio button for 2 seconds to store the current radio station in the corresponding position.
8. Drag to change the radio frequency.
9. Sound effects.
10. Tune into a radio station by manually entering its radio frequency.

Bluetooth

Note: This product only supports calls via Bluetooth and Bluetooth music by connecting the Bluetooth on your phone.

⚠ CAUTION: For your safety, please avoid talking on the phone as much as possible while driving.

Connection method:

Search for the device of the car stereo (Device Name:Eonon) through Bluetooth on your phone to connect it.

Note:

- The operation of different mobile phone types may differ. For detailed instructions, please refer to the user manual of your phone.
- It is not guaranteed that all mobile phones with Bluetooth wireless technology can be connected.
- The distance between this product and your phone must be less than 5 meters when using Bluetooth.
- If your phone supports wireless Android Auto/CarPlay, and it is set correspondingly in the "Smart phone" setting, the unit will automatically access Android Auto/CarPlay after connecting to Bluetooth, but the Bluetooth will not be available at this time. If you want to use Bluetooth, you need to turn off Android Auto/CarPlay on the phone or change the settings in "Smart phone" setting.



1. Calling interface
2. Bluetooth phonebook
3. Bluetooth music
4. Bluetooth connection
5. Tap to connect or disconnect a paired phone device
6. Tap to delete a pairing record

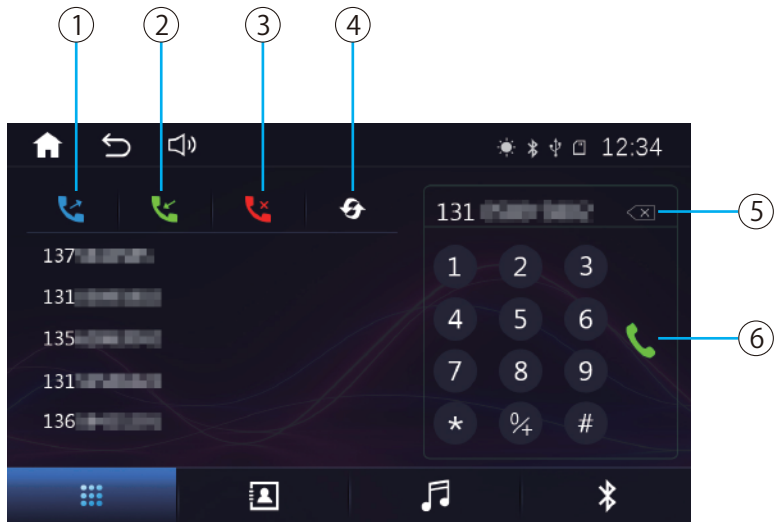

1. Received calls

2. Dialed calls

3. Missed calls

4. Tap to refresh the call history

5. Delete

6. Make a call

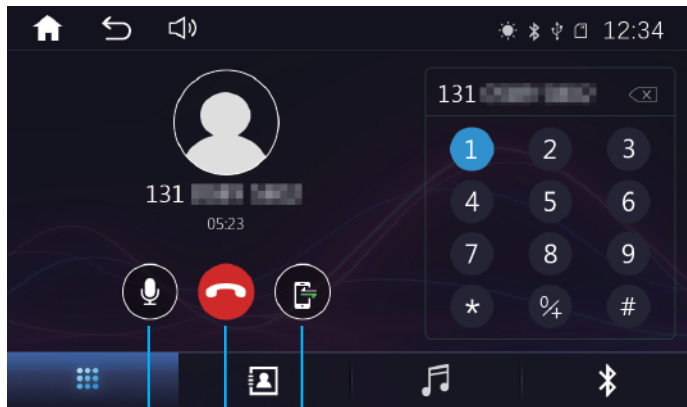

①

②

③

1. Mute the microphone

2. End a call

3. Answer calls via car stereo /mobile phone

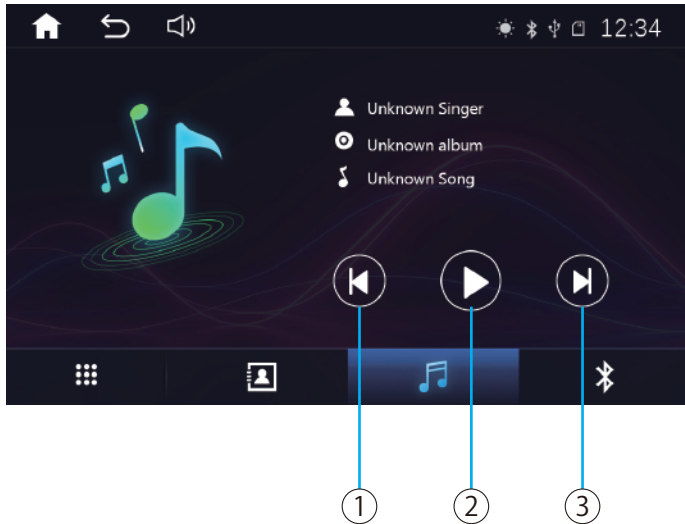

1. Previous

2. Play/Pause

3. Next

Note :

- Resume playback is not supported as the music that Bluetooth device plays is not from the head unit.
- Please avoid using your phone as much as possible when you're playing music via Bluetooth.
- The music will stop playing during a Bluetooth call.

USB/SD

1. Music Playback

Support audio formats like MP3, WMA, WAV, OGG, FLAC, etc.

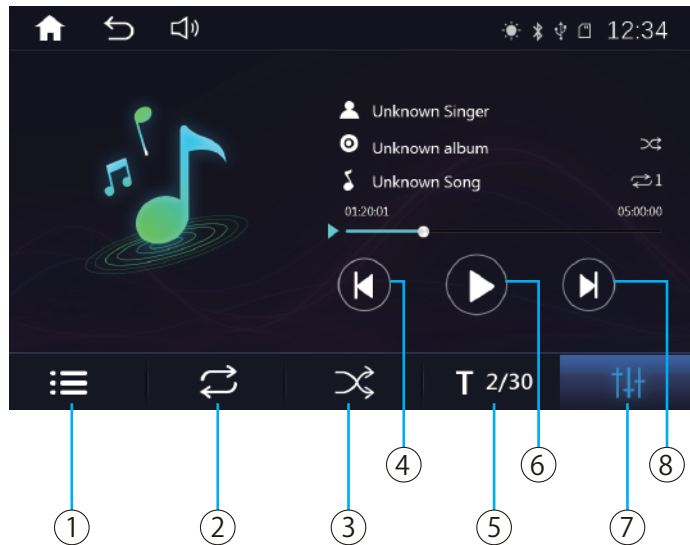

1. View playlist
2. Switch among loop single/ loop all/shuffle loop
3. Shuffle
4. Previous
5. Enter a number of a song to play it
6. Pause/Play
7. Audio settings
8. Next

2. Video Playback

Support video formats like AVI, MKV, MP4, WMV, RMVB, MPG, etc.

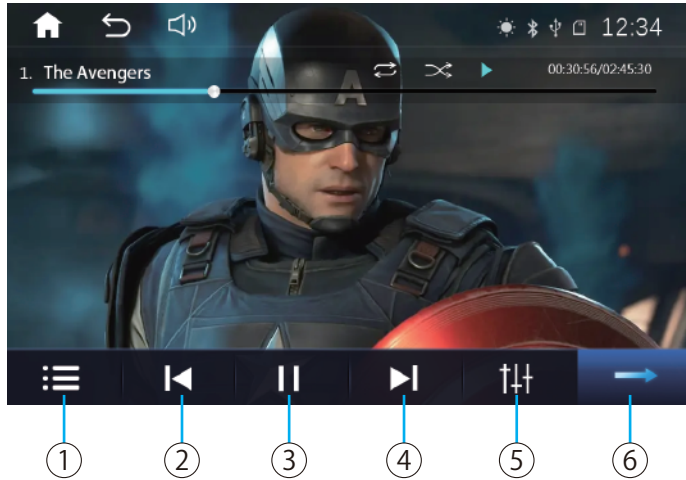

1. View playlist
2. Previous
3. Play/Pause
4. Next
5. Audio settings
6. Next page

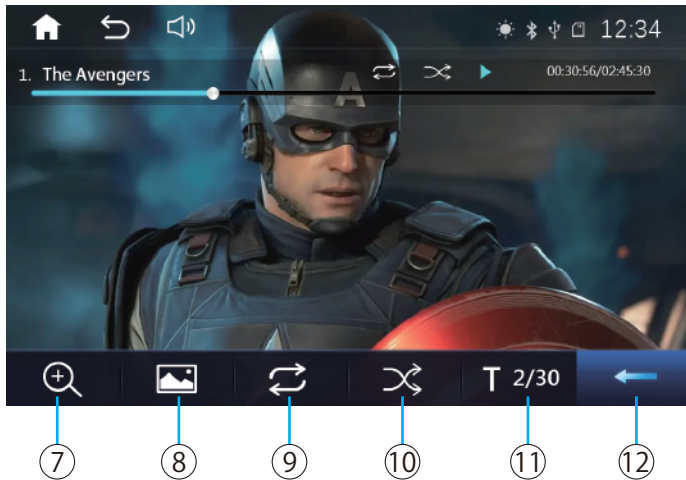

7. Change the aspect ratio

8. Display settings

9. Switch among loop single/ loop all/shuffle loop

10. Shuffle

11. Enter a number of a video to play it

12. Previous page

3. Picture

Support formats including JPG/BMP/PNG.

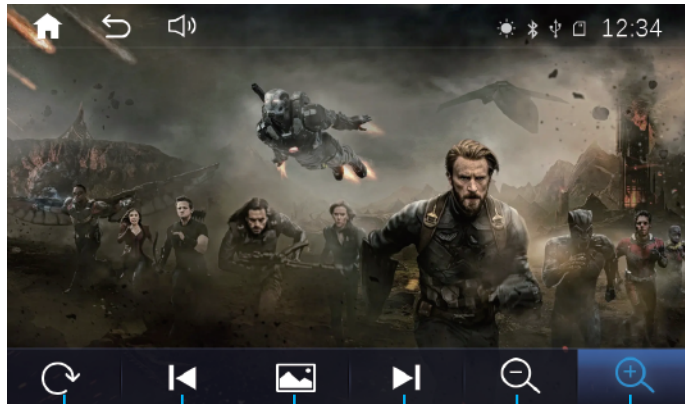

①

②

③

④

⑤

⑥

1. Rotate the picture

2. Previous

3. Play/Pause

4. Next

5. Zoom out the picture

6. Zoom in the picture

Connections

1. Android Auto

Wired Android Auto setup steps:

- ① Go to the Play Store and download the Android Auto App on your phone (as shown below).

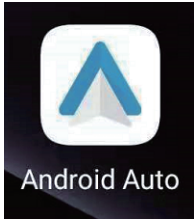

- ② Go to "Setup-->Phone-->Smart phone-->Android Device" and select "Android Auto" on the car stereo.

Android Device

Android Auto >

③ Connect the USB cable of your phone to the USB data port of the unit.

Note:

- Please make sure that your phone supports Google services and Android Auto.
- Please be sure to connect to the USB data port of the unit, or Android Auto will not be available.

Wireless Android Auto setup steps:

① Go to the Play Store and download the Android Auto App on your phone (as shown below).

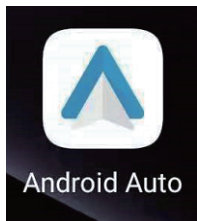

- ② Go to "Setup-->Phone-->Smart phone-->Wireless Device" and select "Android Auto" on the car stereo.

Wireless Device

Android Auto >

- ③ Turn on WiFi and Bluetooth of your phone.
- ④ Find Bluetooth of the head unit (Bluetooth name: Eonon; password: 88888888) and connect to it.
- ⑤ It will turn on Android Auto automatically after connecting to Bluetooth successfully.

Note:

Please make sure that your phone supports Google services and wireless Android Auto.

2. CarPlay

Wired CarPlay setup steps:

- ① Go to "Setup-->Phone-->Smart phone-->iPhone Device" and select "CarPlay" on the car stereo.

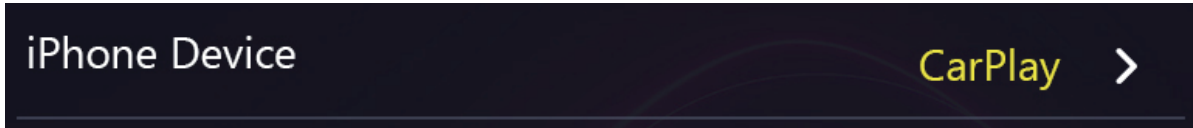

iPhone Device

CarPlay >

- ② Connect the USB cable of your iPhone to the USB data port of the head unit.

Note:

Please be sure to connect to the USB data port of the unit, or Apple CarPlay will not be available.

Wireless CarPlay setup steps:

- ① Go to "Setup-->Phone-->Smart phone-->Wireless Device" and select "CarPlay" on the car stereo.

Wireless Device

CarPlay >

- ② Turn on WiFi and Bluetooth of your iPhone.
- ③ Find Bluetooth of the head unit (Bluetooth name: Eonon; password: 88888888) and connect to it.
- ④ It will turn on CarPlay automatically after connecting to Bluetooth successfully.

3. Screen Mirroring

Setup steps of wired MirrorLink for Android:

- ① Scan the QR code on the unit with your phone and download the AutoLink Pro app.
- ② Go to "Setup-->Phone-->Smart phone-->Android Device" and select "MirrorLink" on the car stereo.

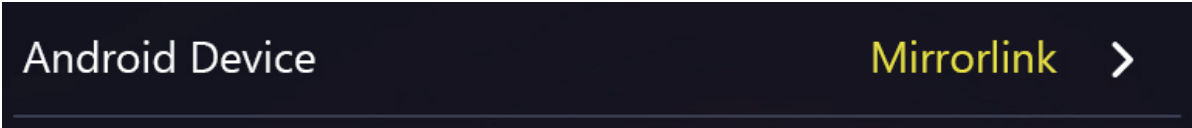

Android Device

Mirrorlink >

- ③ Connect the USB cable of your phone to the USB data port of the head unit.

Note:

Please be sure to connect to the USB data port of the unit, or screen mirroring will not be available.

Setup steps of wireless MirrorLink for Android:

- ① Go to "Setup-->Phone-->Smart phone-->Wireless Device" and select "MirrorLink" on the car stereo.

Wireless Device

Mirrorlink >

- ② Scan the QR code on the unit with your phone and download the AutoLink Pro app.
- ③ Turn on the the Autolink Pro app and search for the device to connect it.

Setup steps of wired MirrorLink for iPhone:

- ① Go to "Setup-->Phone-->Smart phone-->iPhone Device" and select "IOSMirror" on the car stereo.

iPhone Device

iOSMirror >

- ② Connect the USB cable of your iPhone to the USB data port of the head unit.

Note:

Please be sure to connect to the USB data port of the unit, or screen mirroring will not be available.

4. AirPlay

This app is only applicable to iPhone AirPlay.

Setup steps:

- ① Go to "Setup-->Phone-->Smart phone-->Wireless Device" and select "CarPlay" on the car stereo.



Wireless Device

CarPlay >

- ② Turn on WiFi and Bluetooth of your iPhone.
- ③ Find WiFi of the head unit (Name: Eonon; password: 88888888) and connect to it.
- ④ Select Car-AirPlay in AirPlay of iPhone.

Settings

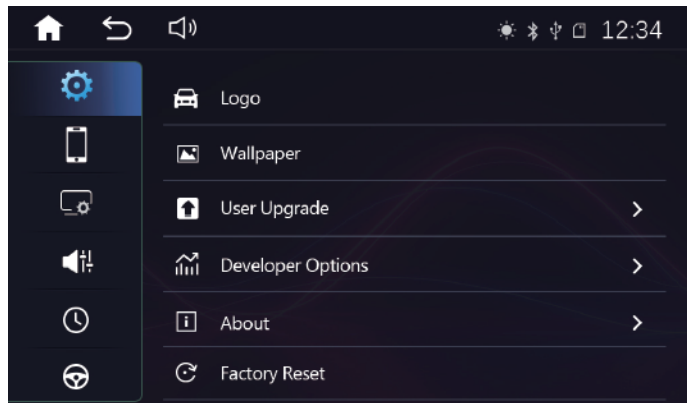

1. General Settings

Reversing Mirror: After turning this setting on, you can mirror the reverse camera image.

Radio Area: To select the radio area.

Panel: For setting the brightness of the display and touch calibration.

Language: To change the language.

Brake Detection: After turning this setting on, the system will check whether the car is in motion or not through brake-in wire. If the parking brake is working, the screen can display the video image, otherwise the screen can't display the video image.

Beep: To turn on/off the key tone.

Keylight: To set the color of the buttons.

Reversing Mute: After turning this setting on, the music will be turned off when in reverse.

Volume: To adjust the volume.

Wallpaper: To set the wallpaper.

About: To view the system information.

Factory Reset: To factory reset the unit.

2. Phone Settings

Smart Phone: To set the functions connected through the phone.

Wifi Device: To view WiFi name and password.

CP&AA Menu On Right: If your driver's seat is on the right, you can turn on this setting to change the sidebar of the CarPlay/Android Auto to the right.

3. Display Settings

To change the parameters of the display.

4. Audio Settings

To set audio settings such as sound field, EQ modes, etc.

5. Time Setting

To set the system time.

6. Steering Wheel Control Settings

Please set button functions on the steering wheel according to the following steps.

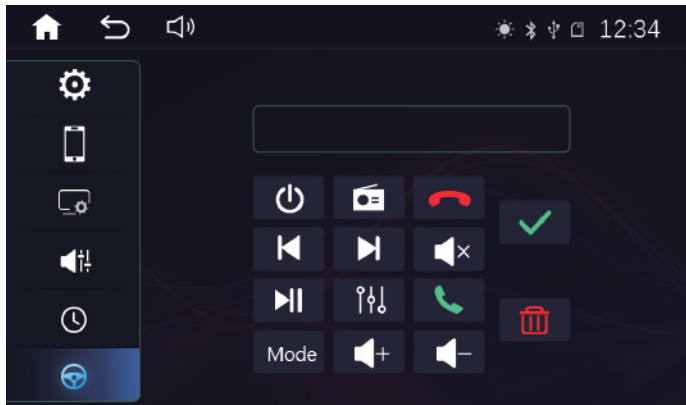

① Connect SWC wires KEY1-5V/KEY2-5V of the car stereo to your car SWC wires.

Note: The SW control function of this car stereo is controlled by analog signal. If your car is controlled by digital signal, then a SW control adapter cable is needed to transfer the digital signal to analog signal.

② Tap  to erase all data.

③ Press the button that needs to be set on the steering wheel.

④ Tap the button corresponding to the function on the car stereo screen.

⑤ It's set successfully once the button color on the car stereo turns blue (like ).

⑥ Repeat 3-5 times to complete the settings of all buttons.

⑦ Tap  to finish the settings.

Specifications

Operating Voltage	DC12V
Maximum Operating Current	$\leq 10A$
Operating Temp	-20°C + 60°C
Storage Temp	-30°C + 70°C
Operating Humidity	45% - 80%(Relative humidity)
Storage Humidity	39% - 80%(Relative humidity)

FAQ

Blank screen/Can't power on:

1. Please press the RST button of the car stereo.
2. Please check if the car stereo has stable DC12V voltage.
3. Please check if the car stereo fuse is burnt out.
4. Please reconnect the BATT+/ACC/GND wires of the car stereo to the BATT+/ACC/GND wires of the original car.

Bluetooth is connected but not working:

It should be that the phone automatically turns on Android Auto/CarPlay after connecting to Bluetooth. To use Bluetooth, please disconnect Android Auto/CarPlay on the phone and then turn on Bluetooth again. Generally, you can disconnect Android Auto/CarPlay by turning off the WiFi of the phone.

Radio is not working properly:

1. Please check if the radio area is set correctly.
2. Please check if the radio antenna is connected properly and reconnect it to have a try.

No sound:

1. Please reconnect the 4 sets of speaker output wires in ISO PORT with the interface of the original car speaker.
2. Please make sure that the amplifier control wire (REM) of the original car is properly connected to the ANT wire of the car stereo.

Images do not automatically change while reversing:

Please connect the reverse control wire of the car stereo to the backup camera trigger wire.

Android Auto is not working:

1. Please make sure that your phone supports Google services and Android Auto. Please note that some mobile phones don't support Android Auto, and some mobile phones only support wired Android Auto but not wireless Android Auto.
2. If your phone supports Android Auto, please install Android Auto APP from the Play store before using it.
3. To use wired Android Auto, please use the original data cable and connect it to the USB data port of the head unit.
3. To use wireless Android Auto, please turn on WiFi and Bluetooth of your iPhone and connect your phone's Bluetooth to the head unit's Bluetooth. Please note that you only need to connect Bluetooth; you don't need to connect WiFi.

CarPlay is not working:

1. To use wired CarPlay, please use the original data cable and connect it to the USB data port of the head unit.
2. To use wireless CarPlay, please turn on WiFi and Bluetooth of your iPhone and connect your phone's Bluetooth to the head unit's Bluetooth. Please note that you only need to connect Bluetooth; you don't need to connect WiFi.